



# GT10000ESQ **POWER**

PROFESSIONAL POWER GENERATOR

## 9000 WATT GENERATOR



Please ensure that you read this manual in full before using your machine and follow the maintenance and operation instructions carefully.

## OPERATING INSTRUCTIONS

## **Contents**

Introduction.....	3
Environmental Protection.....	3
Scope of Product.....	3
Description of Symbols.....	3
Specifications.....	3
Safety Rules.....	4
Unpacking the Generator.....	6
Assembling the Generator.....	7
Features and Controls.....	8
Preparation Before Operating.....	9
Calculating Your Power Need.....	10
Operating the Generator.....	11
Maintenance.....	14
Storage.....	17
Troubleshooting.....	18
Warranty.....	19

## Introduction

Your new GT POWER Generator will more than satisfy your expectations. It has been manufactured under stringent quality standards to meet superior performance criteria. You will find your new tool easy and safe to operate, and, with proper care, it will give you many years of dependable service.



**CAUTION:** Carefully read through this entire Instruction Manual before using your new GT POWER Generator. Take special care to heed the Cautions and Warnings.

Your generator has many features that will make your job faster and easier. Safety, performance, and dependability have been given top priority in the development of this tool, making it easy to maintain and operate.

## Environmental Protection

Recycle unwanted materials instead of disposing of them as waste. All tools, hoses and packaging should be sorted, taken to the local recycling centre and disposed of in an environmentally safe way.



## Scope Of Product

This product is suited for home and camping, back-up power, rural and commercial applications.

## Description Of Symbols

The rating plate on your tool may show symbols. These represent important information about the product or instructions on its use.



Wear hearing protection.  
Wear eye protection.  
Wear breathing protection.



Conforms to relevant standards for electromagnetic compatibility.

## Specifications

AC Output: 230V AC ~ 50Hz

Rated Power: 8000W

Peak Power: 9000W

Phase: Single

Displacement: 459cc

Engine: 16HP, 4 stroke

No Load Speed: 3000 RPM

Fuel Tank Capacity: 25L

Fuel Type: Unleaded petrol

Engine Oil Type: SAE30

Noise Level: 72dBA

Net Weight: 94kg

Starting System: Electric/Recoil

Run Time: 8hrs @ 50% load

Power Outlets: 2

Dimensions: 745 x 545 x 605

## Safety Rules

Read this manual carefully and become familiar with your generator. Know its applications, its limitations and any hazards involved.

Throughout this brochure, on tags and decals affixed to the generator, **DANGER**, **WARNING**, **CAUTION** and **NOTICE** marks are used to alert personnel with special instructions about a particular operation that may be hazardous if performed incorrectly, or carelessly. Observe them carefully. Their definitions are as follows:



**DANGER** indicates a hazard which, if not avoided, will result in death or serious injury.



**WARNING** indicates a hazard which, if not avoided, could result in death or serious injury.



**CAUTION** indicates a hazard which, if not avoided, could result in minor or moderate injury.



**NOTICE** covers some practices which may be not related to personal injury.

A running engine gives off carbon monoxide, an odourless, colourless, poison gas. Breathing carbon monoxide could result in death, serious injury, headache, fatigue, dizziness, vomiting, confusion, seizures, nausea or fainting.

- Operate this product **ONLY** outdoors.
- Install a battery operated carbon monoxide alarm near the bedrooms.
- Keep exhaust gas away from entering a confined area through windows, doors, ventilation intakes, or other openings.

- NEVER operate this product inside any building, carport, porch, mobile equipment, marine applications, or enclosure, even if windows and doors are open.



**WARNING:** *Starter cord kickback (rapid retraction) will pull hand and arm toward engine faster than you can let go which could cause broken bones, fractures, bruises, or sprains resulting in serious injury.*

- When starting engine, pull cord slowly until resistance is felt and then pull rapidly to avoid kickback.
- NEVER start or stop engine with electrical devices plugged in and turned on.



**WARNING:** *Fuel and its vapours are extremely flammable and explosive which could cause burns, fire or explosion resulting in death, serious injury and/or property damage.*

## When Adding or Draining Fuel

- Turn generator engine OFF and let it cool at least 2 minutes before removing fuel cap. Loosen cap slowly to relieve pressure in tank.
- Fill or drain fuel tank outdoors.
- DO NOT overfill tank, Allow space for fuel expansion.
- If fuel spills, wait until it evaporates before starting engine.
- Keep fuel away from sparks, open flames, pilot light, heat, and other ignition sources.
- Check fuel lines, tank, cap and fittings frequently for cracks or leaks. Replace if necessary.
- DO NOT light a cigarette or smoke.

## When Starting Equipment

- Ensure spark plug, muffler, fuel cap and air cleaner are in place.
- DO NOT crank engine with spark plug removed.

## When Operating Equipment

- DO NOT operate this product inside any building, carport, porch, mobile equipment, marine applications or enclosure.
- DO NOT tip engine or equipment at angle which causes fuel to spill.
- DO NOT stop engine by moving choke control to "OFF" position.

## When Transporting or Repairing Equipment

- Transport/move/repair with fuel tank EMPTY or with fuel valve OFF.
- DO NOT tip engine or equipment at angle which cause fuel to spill.
- Disconnect spark plug wire.

## When Storing Fuel or Equipment with Fuel in Tank

- Store away from furnaces, stoves, water heaters, clothes dryers, or other appliances that have light or other ignition source because they could ignite fuel vapours.



**WARNING:** Generator voltage could cause electrical shock or burn resulting in death or serious injury.

- Use approved transfer equipment to prevent back feed by isolating generator from electric utility workers.
- When using generator for backup power, notify utility company.

- Use a ground fault circuit interrupter in any damp or highly conductive area, such as metal decking or steel work.
- DO NOT touch bare wires or receptacles.
- DO NOT use generator with electrical cords which are worn, frayed, bare or otherwise damaged.
- DO NOT operate generator in the rain or wet weather.
- DO NOT handle generator or electrical cords while standing in water, while bare-foot, or while hands or feet are wet.
- DO NOT allow unqualified persons or children to operate or service generator.



**WARNING:** Exhaust heat/gases could ignite combustibles, structures or damage fuel tank causing a fire, resulting in death, serious injury and/or property damage. Contact with muffler area could cause burns resulting in serious injury.

- DO NOT touch hot parts and AVOID hot exhaust gases.
- Allow equipment to cool before touching.
- Keep at least 5 feet (1.5m) of clearance on all sides of generator including overhead.



**CAUTION:** Excessively high operating speeds could result in minor injury and/or generator damage. Excessively low speeds impose a heavy load.

- DO NOT tamper with governor spring, links or other parts to increase engine speeds. Generator supplies correct rated frequency and voltage when running at governed speed.

**WARNING:** Unintentional sparking could cause fire or electric shock resulting in death or serious injury.

## When Adjusting or Making Repairs to the Generator

- Disconnect the spark plug wire from the spark plug and place the wire where it cannot contact spark plug.

## When Testing for Engine Spark

- Use approved spark plug tester.
- DO NOT check for spark with spark plug removed.



**WARNING:** *Starter and other rotating parts could entangle hands, hair, clothing, or accessories resulting in serious injury.*

- NEVER operate generator without protective housing or covers.
- DO NOT wear loose clothing, jewellery or anything that could be caught in the starter or other rotating parts.
- Tie up long hair and remove jewellery.
- DO NOT modify generator in any way.



**NOTICE:** *Exceeding generators wattage/amperage capacity could damage generator and/or electrical devices connected to it.*

- DO NOT exceed the generator's wattage/amperage capacity. See Don't Overload Generator in the Operation section.
- Start generator and let engine stabilize before connecting electrical loads.
- Turn electrical loads OFF and disconnect from generator before stopping generator.



**NOTICE:** *Improper treatment of generator could damage it and shorten its life.*

- Use generator only for intended uses.
- If you have questions about intended use,

ask dealer or contact local service center.

- Operate generator only on level surfaces.
- DO NOT expose generator to excessive moisture, dust, dirt, or corrosive vapor.
- DO NOT insert any object through cooling slots.
- If connected devices overheat turn them off and disconnect them from generator.
  - or if electrical output is lost.
  - or if equipment sparks, smokes, or emits flames.
  - or if unit vibrates excessively.

## Unpacking the Generator

- Set the carton on a rigid flat surface.
- Remove everything from carton except generator.
- Open carton completely by cutting each corner from top to bottom.
- Leave generator on carton to install wheel kit.

## Packing Contents

- 1 x Owner's Manual
- 2 x Wheels
- 1 x Handle Assembly
- 2 x Wheel Axles
- 2 x Axle Split Pins
- 1 x Gen Set
- 1 x Hardware Bag (includes 1 x Spark Plug Socket; 1 x Extension Tool)

## Assembling the Generator

The generator requires some assembly prior to using it.

### Assembling The Accessory Kit

The wheels are designed to greatly improve the portability of the generator.

 **NOTE:** *The wheels are NOT intended for on-road use.*

#### 1. Refer to diagrams to install wheels as shown.

- Slide the axle through the frame brackets.
- Slide on the hub, wheel and flat washer, then insert the split pin through the wheel axle hole.
- Bend the split pin tabs outward to lock the pin in place.

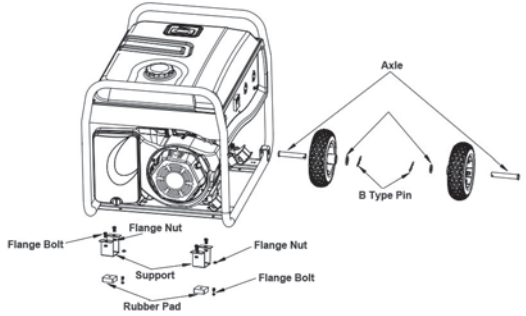

#### 2. The wheel bumpers as shown.

- Insert an M6 bolt through the rubber bumper and insert an M8 bolt through the bottom of the bumper bracket. Secure the bolt with an M8 flange nut.
- Install an M8 bolt through the generator frame and through top of the bumper bracket. Secure the bolt with an M8 flange nut.

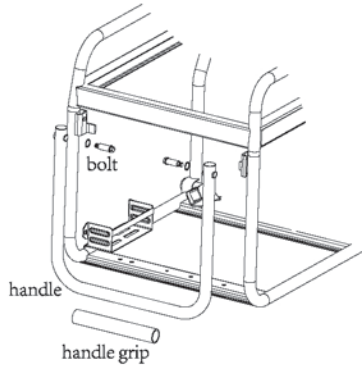

#### 3. Refer to following diagram to install the handle assembly as shown.

- Insert the handle bracket onto the generator frame and secure with two M8 bolts and two M8 flange nuts.
- Align the handle assembly holes with the handle bracket holes and secure with one M8 bolt and one M8 flange nut.

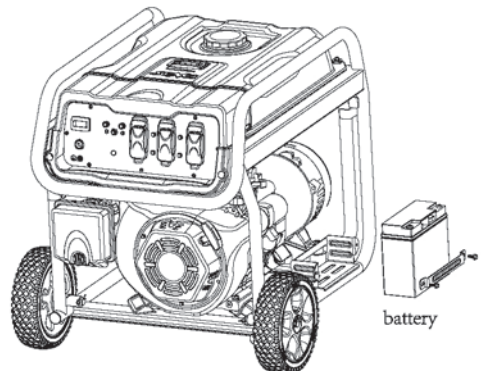

## Features and Controls

Read this Operating Manual and the Safety Rules section before operating your generator. Compare the illustrations with your generator, to familiarise yourself with the locations of various controls and adjustments. Save this manual for future reference.

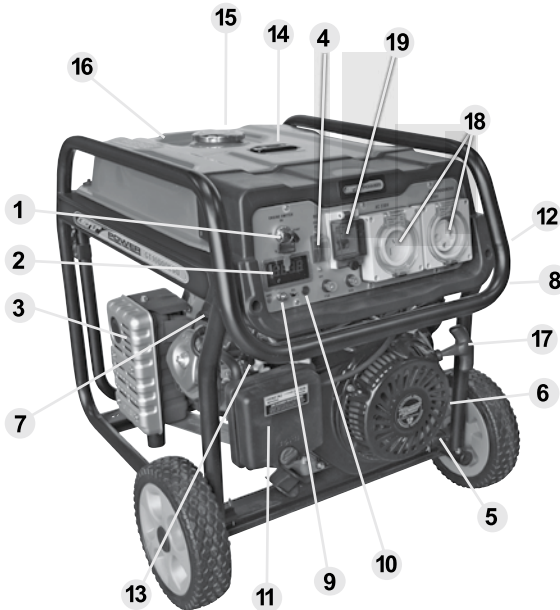

1. Engine Switch
2. Voltmeter
3. Muffler
4. AC Circuit Breaker
5. Oil Drain Plug
6. Oil Fill Cap/Dipstick
7. Spark Plug
8. Battery
9. Earth Terminal
10. Low Oil Warning Light
11. Air Cleaner
12. Fuel Valve
13. Choke Lever
14. Fuel Gauge
15. Fuel Tank Cap
16. Fuel Tank
17. Recoil Starter
18. 230V AC Receptacle
19. RCD



## Preparation before Operating

### Adding Engine Oil

Please add correct oil before starting the generator.

Above 5°C - use **SAE 30**

Between 5°C to -15°C - use **10W-30**

Oil Capacity - 1100ml

 **NOTE:** *Improper treatment of generator could damage it and shorten its life. DO NOT attempt crank or start the engine before it has been properly serviced with the recommended oil. This could result in an engine failure.*

- Place generator on a flat, level surface.
- Remove oil cap and dipstick. Wipe dipstick clean.
- Slowly fill oil into engine through the oil filter until it reaches the full mark on the dipstick.
- Stop filling occasionally to check oil level. Be careful to not overfill.
- Install oil fill cap and fasten the cap properly.
- Check engine oil level before starting each time thereafter.

### Adding Fuel

 **DANGER:** *Never fill tank indoors. Never fill fuel tank when engine is running or hot. Turn generator engine OFF and allow engine to cool entirely before filling fuel tank. Avoid spilling gasoline on HOT engine. Keep fuel away from sparks, open flames, pilot lights, heat, and other ignition sources. DO NOT light a cigarette or smoke when filling the fuel tank. Fuel*

*is highly FLAMMABLE and its vapours are EXPLOSIVE.*

- Use only regular UNLEADED gasoline. Do not use any fuel with more than 10% added ethanol, and never use E85 fuel.
- Do not mix oil with gasoline.
- Install fuel cap and wipe up any spilled gasoline.

 **CAUTION:** *Do not overfill the fuel tank. Allow space for fuel expansion. IF the fuel tank is overfilled, fuel can overflow onto a HOT engine and cause FIRE or EXPLOSION. If fuel spills, wait until it evaporates before starting engine. Check fuel lines, tank, cap and fittings frequently for cracks or leaks. Replace if necessary.*

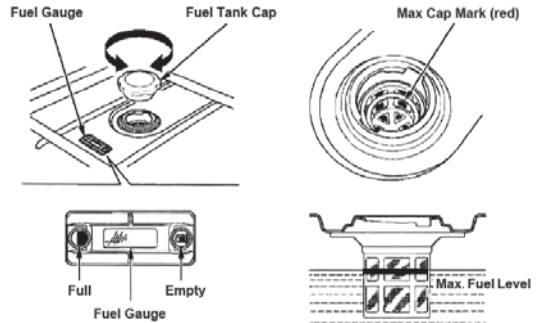

 **IMPORTANT:** *It is important to prevent gum deposits from forming in fuel system parts such as the carburetor, fuel hose or tank during storage. Alcohol-blended fuels (called gasohol), ethanol or methanol) can attract moisture, which leads to separation and formation of acids during storage. Acidic gas can damage the fuel system should be emptied before storage for 30 days or longer. See the "Storage" section. Never use engine or carburetor cleaner products in the fuel tank as permanent damage may occur.*

## Earthing the Generator

Proper earthing of the generator will help prevent electrical shock in the event of earth fault condition in the generator or in connected electrical devices. Proper earthing also helps dissipate static electricity, which often builds up in un-earthed devices.



**NOTICE:** Synchronous generators such as this model may not be suitable to power sensitive electronic

equipment such as computers and other equipment with digital control circuitry. Operation of such equipment with this model generator may cause issues and/or permanent damage to the equipment. For powering sensitive electronic equipment, we recommend to use a GT Power inverter generator. Please contact your GT Power dealer for further details.

## Calculating Your Power Needs

Firstly add up all the “running wattage” requirements for all items that you need to power simultaneously. Next, add to that total the highest of the “starting wattages” you listed down. Now you know approximately how much power you need to start and run your appliances and equipment.

Appliances	Approx Run (W)	Approx Start (W)	Appliances	Approx Run (W)	Approx Start (W)
Microwave 750W	750	1200	Central Air Conditioner:		
Coffee Maker	1750	1750	10,000 BTU	1500	2200
Electric Clothes Drier	5750	5750	24,000 BTU	3800	5000
Washing Machine	1150	2300	32,000 BTU	5000	6500
Refrigerator	700	2200	Room Air Conditioner		
Lights	100	100	10,000 BTU	1500	2200
Colour Television	350	350	Circular Saw 7 1/4"	1400	2300
Electric Frypan	1500	1500	Chainsaw 2HP	1100	2500
Dehumidifier	400	400	Portable Air Compressor	1200	3600
Computer - Desktop	700	700	Hand Drill 1/2"	600	900
VCR	50	50	Drill 1/2"	600	900
Dishwasher - Cool Dry	700	1400	Battery Charger - 15 amp	500	700
- Hot Dry	1450	2000	Electric Welder - 200 amp AC	9000	9000
Toaster - 2 Slice	1250	1250	Jigsaw	300	400
- 4 Slice	1600	1600	Electric Weed Trimmer	500	650
Freezer	2200	2500	Router	1000	1300
Hair Dryer	800-1700	800-1700	Belt Sander	1000	1300
Steam Iron	1800	1800	Table Saw 10"	1750	4250
Garage Door Opener - 1/4 HP	550	1100	Bench Grinder	1400	2450
- 1/3 HP	725	1400	Concrete Mixer 3.5c/f	1900	2500
Radio	200	200	Band Saw	1100	1350
Blender	375	500	Power Drill - Medium	1000	1200
Sump Pump 1/2 HP	1050	2150	- Heavy Duty	1500	1800
Well Pump 1/2 HP	1000	2100	Angle Grinder - 100mm	1000	1200
Household Water Pump	1200	2700	- 230mm	2400	2700

This chart lists average power requirements. Your particular tool or appliance may require more or less than the listed wattage. Where START wattage is the same as RUN wattage, this signifies no additional power is required for starting.

## Operating the Generator

### Starting the Engine



**WARNING:** *Never start or stop engine with electrical devices plugged into the receptacles and devices turned on.*

Unplug all electrical loads from the unit's receptacles before starting the engine. Make sure the unit is in a level position.



Turn the engine switch to "ON" position.

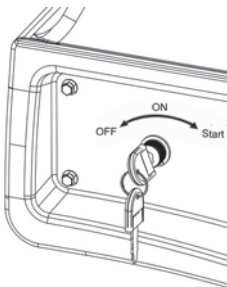

Turn fuel switch to "ON" position.

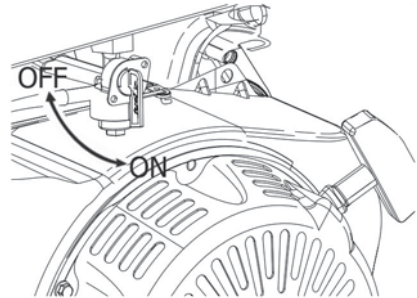

Move engine choke lever to the "CHOKE" position.

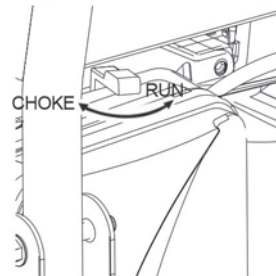

For electric start, turn and hold key in start switch to "START" position until generator starts. To prolong the life of starter components, DO NOT hold key in "start" position for more than 15 seconds, and pause for at least 1 minute between starting attempts.

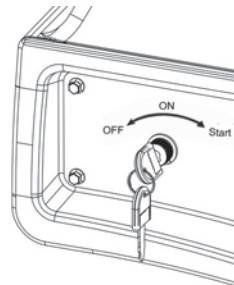

For recoil start, firmly grasp the recoil handle and pull slowly until increased resistance is felt. Pull rapidly up and away.

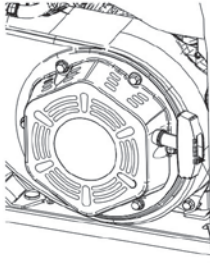

Recoil Starter

- When engine starts, move choke lever to 1/2 “CHOKE” position till engine runs smoothly and then fully into “RUN” position. If engine falters, choke back to 1/2 “CHOKE” position till engine running smoothly and then fully into “RUN” position again. If battery is unavailable, use manual starting instructions.
- If engine is choking and running move choke lever to the “CHOKE” position and repeat starting instructions.

 **WARNING:** Starter cord kickback (rapid retraction) will pull hand and arm toward engine faster than you can let go which could cause broken bones, fractures, bruises, or sprains resulting in serious injury. When starting engine, pull cord slowly until resistance is felt and then pull rapidly to avoid kickback. Never start or stop engine with electrical devices plugged in and turned on.

- If engine fails to start after 3 pulls, or if unit shut down during operation, make sure unit is on a level surface and check for proper oil level in crankcase. This unit is equipped with a low oil protection device. Oil must be checked and at proper level for engine to start and run.



**WARNING:** Exhaust heat/ gases could ignite combustible, structures or damage fuel tank causing a fire, resulting in death, serious injury and/or property damage. Contact with muffler area could cause burn resulting in serious injury. DO NOT touch hot parts and AVOID hot exhaust gases. Allow equipment to cool before touching.

- Keep at least 150cm of clearance on all sides of generator including overhead.
- Replacement parts must be the same and installed in the same position as the original parts



**IMPORTANT:** Do not overload the generator. Also, do not overload individual panel receptacles. These outlets are protected against overload with push-to-reset-type circuit breakers. If amperage rating of any circuit breaker is exceeded, that breaker opens and electrical output to that receptacle is lost.

## Connecting Electrical Loads

- Let engine run till stable and warm up for a few minutes after starting.
- Plug in and turn on the electrical loads.
- Add up the rated watts (or amps) of all loads to be connected at one time. This total should not be greater than (a) the rated wattage/amperage capacity of the generator or (b) circuit breaker rating of the receptacle supplying the power.



**NOTICE:** Start generator and let engine stabilise before connecting electrical loads. Connect electrical loads in OFF position then turn ON for operation. Turn electrical loads

*OFF and disconnect from generator before stopping generator.*



**NOTICE:** *Exceeding generators wattage/ampere capacity could damage generator and/or electrical devices connected to it. DO NOT exceed the generator's wattage/ampere capacity.*

Overloading a generator in excess of its rated wattage capacity can result in damage to the generator and to connected electrical devices.

Observe the following to prevent overloading the unit:

- Add up the total wattage of all electrical devices to be connected at one time. This total should NOT be greater than the generator's wattage capacity.



**NOTICE:** *The rated wattage of lights can be taken from light bulbs. The rated wattage of tools, appliances and motors can usually be found on a data label or decal affixed to the devices.*

*If the appliance, tool or motor does not give wattage, multiply volts times ampere rating to determine watts (volts x amps = watts). Some electric motors, such as induction types, require about three times more watts of power for starting than for running. This surge of power lasts only a few seconds when starting such motors. Make sure to allow for high starting wattage when selecting electrical devices to connect to the generator:*

- Figure the watts needed to start the largest motor.

- Add to that figure the running watts of all other connected loads. The wattage reference guide is provided to assist in determining how many items the generator can operate at one time.

## The 5 Function Digital Output Meter (2)

The control panel is equipped with an advanced digital 5 function meter that displays important information about the generator when it is operation. The meter displays 1 function at a time, press the mode change button on the meter to cycle through each value.

The meter functions are as follows:

- Output voltage in volts (V)
- Output current in amps (A)
- Output power in watts (P)
- Output frequency in hertz (Hz)
- Total operating hours (H)

## RCD Output Protector (19)

This model is equipped with an earth leakage RCD protector. This will disconnect the power output when the RCD detects leakage current in the load greater than 30mA. This is designed that 30mA is considered the 'safe' current level the human body can conduct without serious injury, in the event of a person coming into contact with a live conductor due to an electrical fault in an appliance. If the RCD trips during operation, remove the appliance(s) from the generator, reset the RCD switch and switch the appliance on again. If this problem persists, please have an electrician check the appliance.



**NOTE:** *When connecting the generator to a fixed installation or a large number of loads through a multi box or similar, the total current leakage across multiple loads and the power distribution system may exceed 30AmA, which creates nuisance tripping of the RCD. For this reason, in most power distribution systems, each power connection point is usually protected by its own RCD, rather than a single RCD for the complete system. To address this issue, it will be required to bypass the RCD protector in the generator control panel. Please have an electrician check there is no earth leakage problem with the connected load before bypassing the RCD protection.*

## Stopping The Engine

- Shut off all loads then unplug the electrical loads from generator panel receptacles. Never start or stop the engine with electrical devices plugged in and turned on.
- Let engine run at no-load for several minutes to stabilise the internal temperatures of engine and generator.
- Move ON/OFF switch to OFF position.
- Close fuel valve.

## Low Oil Level Shutdown System

The engine is equipped with a low oil level sensor that shuts down the engine automatically when the oil level drops below a specified level.

- If the engine shuts down by itself and the fuel tank has enough gasoline, check engine oil level.

## High Altitude

At altitudes over 1500 metres, a minimum 91 octane gasoline is acceptable. To remain emissions compliant, high altitude adjustment is required. Operation without this adjustment will cause decreased performance, increased fuel consumption, and increased emissions. See an authorised dealer for high altitude adjustment information. Operation of the engine at altitudes below 750 metres with the high altitude kit is not recommended.

## Maintenance

### Maintenance Schedule

Follow the calendar intervals shown below. More frequent service is required when operating in adverse conditions.

#### First hrs:

Change engine oil

#### Every 8hrs or daily:

Clean debris

Check engine oil level

#### Every 25hrs or weekly:

Clean engine air filter

#### Every 50hrs or 6 monthly:

Change engine oil

#### Yearly:

Replace engine oil filter

Service fuel valve

Service spark plug

Check muffler and spark arrester

Clean cooling system

## General Recommendations

The warranty of the generator does not cover items that have been subjected to

operator abuse or negligence. To receive full value from the warranty, the operator must maintain the generator as instructed in this manual.

Some adjustments will need to be made periodically to properly maintain the generator.

All adjustments in the Maintenance section of this manual should be made at least once each season. Follow the requirements in the "Maintenance Schedule".



**NOTE:** *Once a year replace the spark plug and replace the air filter. A new spark plug and clean air filter assure proper fuel-air mixture and help the engine run better and last longer.*

## Generator Maintenance

Generator maintenance consists of keeping the unit clean and dry. Operate and store the unit in a clean dry environment where it will not be exposed to excessive dust, dirt, moisture or any corrosive vapours. Cooling air slots in the generator must not become clogged with debris.

- Check for any foreign materials while changing the engine oil and report to repair agent if necessary
- Check the cleanliness of the generator frequently and clean when dust, dirt, oil, moisture or other foreign substances are visible on its exterior surface.



**CAUTION:** *Never insert any object or tool through the air cooling slots, even if the engine is not running.*



**NOTE:** *DO NOT use a garden hose to clean generator. Water can enter the engine fuel system and cause*

*problems. In addition, if water enters the generator through cooling air slots, some water will be retained in voids and crevices of the rotor and stator winding insulation. Water and dirt build-up on the generator internal windings will eventually decrease the insulation resistance of these windings.*

## To Clean the Generator

- Use a damp cloth to wipe exterior surfaces.
- A soft, bristle brush may be used to remove dirt, oil etc.
- A vacuum cleaner may be used to pick up loose dirt and debris.
- Low pressure air (not to exceed 25psi) may be used to blow away dirt. Check cooling air slots and openings on the generator. These openings must be kept clean and unobstructed.

## Engine Maintenance



**DANGER:** *When working on the generator, always disconnect spark plug wire from spark plug and keep wire away from spark plug.*

## Changing the Oil

Change the oil after the first five hours of operation, then every 50 hours thereafter. If running this unit under dirty or dusty conditions, or in extremely hot weather, change the oil more often.



**CAUTION:** *Hot oil may cause burns. Allow engine to cool before draining oil. Avoid prolonged or repeated skin exposure to used oil. Thoroughly wash exposed areas with soap.*

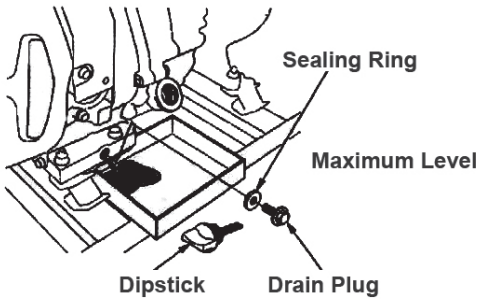

- Stop the engine and pull off the spark plug wire.
- Clean the area around the spark plug and remove it from the cylinder head.
- Set the spark plug's gap to 0.70-0.80 mm. Install the correctly gapped spark plug into the cylinder head and torque to 15ft/lbs.

## Spark Arrestor

- Shut off generator and allow the engine and muffler to cool down completely before servicing spark arrestor (located on the back of the muffler).
- Remove the clamp and spark arrestor screen.
- Clean the spark arrestor screen with a small wire brush.
- Replace the spark arrestor if it is damaged.
- Install the Spark arrestor reversely.

## Service Air Filter

The engine will not run properly and may be damaged if using a dirty air filter.

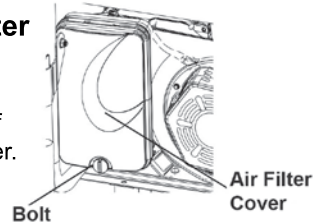

Follow the instructions below to change the oil while the engine is cooling down:

- Clean area around oil drain plug.
- Remove oil drain plug from engine to drain oil completely into a suitable container.
- When oil has completely drained, install oil drain plug and fasten securely.
- Fill engine with recommended oil. (See "Before Starting the Generator" for oil recommendations).
- Wipe up any spilt oil.
- Dispose used oil at a proper collection centre.

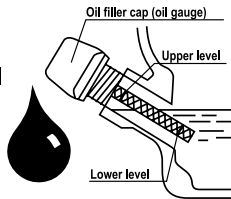

## Replacing the Spark Plug

- Use spark plug F6TC, BPR6ES or Champion RN14YC. Replace the plug once each year. This will help the engine start easier and run better.

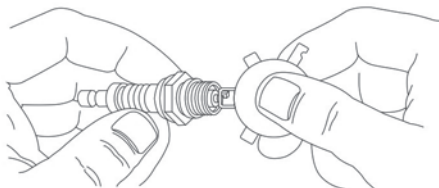

Replace the air filter once a year. Clean or replace more often if operating under dusty conditions.

- Remove air filter cover.
- Wash in soapy water. Squeeze filter dry in a clean cloth (DO NOT TWIST).
- Clean air filter cover before re-installing it.



## Valve Clearance

After the first 50 hours of operation, check the valve clearance in the engine and adjust if necessary.



**IMPORTANT:** *If feeling uncomfortable about doing this procedure or the proper tools are not available, please take the generator to the nearest service centre to have the valve clearance adjusted. This is a very important step to ensure long life for the engine.*

ITEM	SPECIFICATION
Spark Plug Gap	0.028 - 0.031 in (0.70mm - 0.80mm)
Valve Clearance	IN: 0.15mm ± 0.02mm (cold) EX: 0.20mm ± 0.02mm (cold)

## General

The generator should be started at least once every seven days and be allowed to run at least 30 minutes. If this cannot be done and the unit must be stored for more than 30 days, use the following information as a guide to prepare it for storage.



**DANGER:** *NEVER store engine with fuel in tank indoors or in enclosed, poorly ventilated areas where fumes may reach an open flame, spark or pilot light as on a furnace, water heater, clothes dryer or other gas appliance.*



**CAUTION:** *Avoid spray from spark plug holes when cranking engine.*



**DANGER:** *Drain fuel into approved container outdoors, away from open flame. Be sure engine is cool. Do not smoke.*

## Other Storage Tips

- Do not store gasoline from one season to another.
- Replace the gasoline can if it starts to rust. Rust and/or dirt in the gasoline will cause problems with the carburetor and fuel system.
- If possible, store the unit indoors and cover it to give protection from dust and dirt. **BE SURE TO EMPTY THE FUEL TANK.**
- If it is not practical to empty the fuel tank and the unit is to be stored for some time, use a commercially available fuel stabiliser added to the gasoline to increase the life of the gasoline.
- Cover the unit with a suitable protective cover that does not retain moisture.



**DANGER:** *NEVER cover the generator while engine and exhaust area are warm.*

## Storage

It is important to avoid gum deposits from forming in essential fuel system parts such as the carburetor, fuel hose or tank during storage. Also, experience indicates that alcohol-blended fuels (called gasohol, ethanol or methanol) can attract moisture, which leads to separation and formation of acids storage. Acidic gas can damage the fuel system of an engine while in storage.

To avoid engine problems, the fuel system should be emptied before storage of 30 days or longer, as follows:

- Remove all gasoline from the fuel tank.
- Start and run engine until engine stops from lack of fuel.

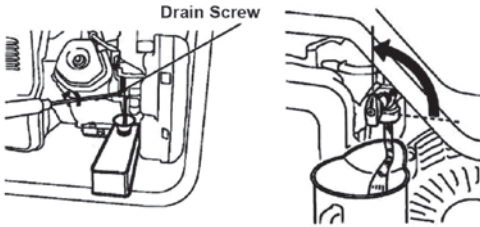

- While engine is still warm, drain oil from crankcase. Refill with recommended grade.

- Remove spark plugs and pour about 15ml of engine oil in the cylinders. Cover spark plug hole with rag. Pull the recoil starter a couple times to lubricate the piston rings and cylinder bore.
- Install and tighten spark plugs. Do not connect spark plug wires.
- Clean the generator outer surfaces. Check that cooling air slots and openings on generator are open and unobstructed.
- Store the unit in clean, dry place.

## Troubleshooting

Trouble	Possible Cause	Suggested Remedy
<b>Engine will not start or will not keep running</b>	1. Low on fuel	1. Add fuel / oil mix
	2. Low on oil	2. Check oil level and top up
	3. Faulty spark plug	3. Replace spark plug
	4. Choke in wrong position	4. Adjust choke accordingly
	5. Fuel tap in closed position	5. Open fuel tap
	6. Unit loaded during start-up	6. Remove load from unit
	7. Spark plug wire loose	7. Attach wire to spark plug
	8. Dirty fuel filters	8. Clean filters as per instructions
<b>No electrical output</b>	1. Faulty receptacle	1. Have service centre replace receptacle
	2. Circuit breaker kicked out	2. Depress and reset
	3. Defective AVR	3. Have service centre replace AVR
	4. Faulty power cord	4. Replace cord
<b>Repeated circuit breaker tripping</b>	1. Overload	1. Reduce load
	2. Faulty cords or equipment	2. Check for damaged, bare or frayed wires on equipment. Replace.
	3. Circuit breaker is faulty	3. Have service centre replace circuit breaker
<b>Generator overheating</b>	1. Generator overloaded	1. Reduce load
	2. Insufficient ventilation	2. Move to adequate supply of fresh air

## Warranty

As part of an on-going commitment to excellence in product support, Euroquip offers a comprehensive product warranty program.

### 1. THIS WARRANTY:

The benefits provided to the consumer in this warranty are in addition to other rights and remedies of a consumer under the New Zealand Consumer Guarantees Act 1993 and any other laws in relation to the products to which this warranty relates. This warranty:

- Covers the product against faulty materials or workmanship; and
- Covers the replacement of parts, the repair labour used, a refund of the price of the product or replacement of the machine, or other compensation for the remainder of the warranty period.

This product warranty is only applicable to the original purchaser of the machine and only purchases made from Euroquip Authorized Retailers.

### 2) WARRANTY PERIODS:

**Commercial Warranty\*: 2 Years (24 months)**  
**Domestic Warranty\* : 4 Years (48 months)**

*Domestic Warranty applies to domestic use of the product: Personal, residential, or household use only. Commercial Warranty applies to commercial or business use of the product: All uses other than domestic use, including use for income-producing (including farming) or rental purposes.*

\*These GT Power Warranty periods are for products that are:

- Purchased from a New Zealand GT Power Dealer after 01/06/23
- Serviced by a GT Power Dealer in accordance with the GT Power service schedule, using genuine parts and the correct grade of oil (proof required)
- Meeting all other warranty requirements

**NOTE:** These warranty conditions apply to New Zealand only.

Euroquip warrants each new GT Power machine free from defect in material and workmanship under normal use and routine servicing, for the warranty periods specified. Conditional to the limitations and exclusions list below. The warranty period begins when the product is purchased by the end user. Warranty is not transferrable and is only claimable by the original purchaser.

Proof of purchase documentation with product serial number must be provided. If it has been lost and Euroquip does not have a record of the purchaser's details, the warranty period shall be calculated from the appropriate dealer wholesale sale date.

The purchaser must keep a record of all service and maintenance history as proof of servicing history. This may be requested when assessing any future warranty claims. The decision that an issue with a product qualifies as a warranty claim is made at the sole jurisdiction of Euroquip.

No costs incurred will be considered under warranty if repairs or maintenance are carried out by any party other than a Euroquip Approved Service Agent, unless with prior consent in writing from Euroquip.

It is the full responsibility of the purchaser to deliver the product under warranty to the nearest relevant service agent or product reseller. Warranty does not cover transportation costs including call outs, mileage and freight costs.

Customers are responsible for the care and cleaning of their product prior to sending it to our service centre. Any product being sent us must be thoroughly cleaned. Depending on what the product has come into contact with, it could pose an Occupational/ Work Health and Safety risk for our staff and or/service agents to inspect, repair or service a product that has come into contact with a hazardous substance. If we are asked to inspect, repair or service a product that has come into contact with a hazardous substance such as chemicals, asbestos or silica dust, we may not be able to inspect, service or repair the product. If this is the case, we will inform the purchaser and the product will be returned.

If a product is repaired under warranty, parts and labour required for the repair will be supplied at no charge. All defective parts replaced under warranty become property of Euroquip. Consumable items such as, but not limited to, oils, coolants, filter and spark plugs shall be the responsibility of the owner. Warranty assessment and repair will be scheduled and executed according to the normal work flow at the service location and depending on the availability of suitable replacement parts.

This warranty policy is an additional benefit and does not supersede the legal rights of any customer, reseller or service agent.

Should any issue be found to be a combination of a warranty failure and a non-warranty issue such as incorrect charging techniques, the repair cost component to rectify and repair the non-warranty failure is the **customer's** full responsibility.

### 3) EXCLUSIONS:

- Warranty does not cover parts that are subject to wear and tear from usage and/or damage which results from neglect of periodic maintenance.
- Evidence must be provided that the product has been maintained and serviced suitably for a claim to be considered under warranty.
- Batteries supplied with your product are warranted against defect for 3 months and does not include lack of charge due to non-use. Consumable items such as, but not limited to, oils, coolants, filters, spark plugs and batteries shall be the responsibility of the purchaser.
- Failure caused by incorrect operation of the product as specified in the manual either intentionally or by error.
- Lack of proper care and maintenance of the product.
- Any damage which results from unavoidable natural disasters, fire, collision, theft, etc.
- Any normal wear or deterioration, such as that of sliding or rotating parts caused under normal operating conditions.
- Any damage that results from misuse or use beyond the imitations of the products intended purpose (such as overloading or use under abnormal conditions).
- External circumstances such as product deterioration or corrosion due to environmental conditions like heat, cold, salt spray, sand or due to the passage of time
- Normal phenomena such as noise, vibration or oil seepage which are considered by Euroquip as not affecting the quality, function or performance of the product.
- Any damage due to improper storage or transport.
- Consumable replacement items: Spark plugs, contact points, shear pins, fuel strainers, oil filter elements, air cleaner elements, brake shoes or pads, clutch components, fuses, motor brushes, gaskets, tube or hoses, belts, cutting blades, light bulbs, serviceable bearings. Petroleum and others fluids: Oil, grease, battery electrolyte, and radiator coolant. Other items specified by Euroquip.
- Periodical maintenance items such as cleaning, inspection and adjustments.
- Contaminated fuel
- Modifications or installations of other products to the product
- Damage that results from the use of non-genuine parts, lubricant or fluid not approved by Euroquip
- Any repair and/or adjustment to correct improper or poor quality work previously performed.
- Attempted repair/ service by a party other than an Approved Service Agent, or any repair undertaken prior to approval of warranty be Euroquip is not covered under warranty.
- Warranty does not cover pre delivery service and adjustment, or failure that may occur as a result of lack of/ incorrect pre delivery service and adjustment. Warranty does not cover any incidental, indirect or consequential loss, damage, personal injury, or expense that may result from any defect, failure, malfunction, or misuse of a product.
- Any product that is found to have come into contact with hazardous substances such as chemicals, asbestos or silica dust and NOT been industrially cleaned prior to servicing.

### 4) HOW TO CLAIM WARRANTY:

In the event you are faced with a manufacturing fault with your GT Power product, you can claim a repair or part replacement under warranty if the following conditions are fulfilled:

- The problem is related to production quality or specifications of the machine
- The machine is within the warranty period outlined in schedule
- The issue does not fall within the warranty exclusions listed

If the criteria above is met, and you would like to request a warranty, then please go online to <https://www.euroquip.co.nz/Service-Request-End-User> and log your warranty claim.





Congratulations on your new GT POWER product. We are proud to have you as our customer and will strive to provide you with the best service and reliability in the industry. This product is backed by our extensive warranty. To locate your nearest distributor or service agency call **0800 387 678**, or email us at **[customerservice@euroquip.co.nz](mailto:customerservice@euroquip.co.nz)**.