

- I **MANUALE D'USO E MANUTENZIONE** *elettrocompressori a pistone lubrificati*
- GB **INSTRUCTION MANUAL AND SAFETY INSTRUCTION**  
*reciprocating piston air compressor oil lubricated*
- F **MANUEL D'UTILISATION ET CONSIGNES DE SÉCURITÉ DU COMPRESSEUR**  
*électrocompresseur à piston lubrifiés*
- D **BEDIENUNGS-UND WARTUNGSHANDBUCH**  
*elektrokompRESSOREN mit geschmiertem kolben*
- NL **GEBRUIKS- EN ONDERHOUDSHANDBOEK**  
*gesmeerde elektrocompressor met zuiger*
- DK **BRUGER-OG VEDLIGEHODELSES VEJLEDNING**  
*oliesmurte elektrokompressorer med stempel*
- E **MANUAL DE USO Y MANTENIMIENTO** *electrocompresores de piston lubricados*
- P **MANUAL DE USO E MANUTENÇÃO** *compressores eléctricos a pistão lubrificados*
- SF **KÄYTTÖ- JA HUOLTO KÄSIKIRJA**  
*rasvoitetut, männällä varustetut sähkökompressorit*
- S **BRUKSANVISNING OCH UNDERHÅLLSHANDBOK**  
*elektriska kompressorer med smorda kolvar*

**GM - TR - VX - AB - CCS**

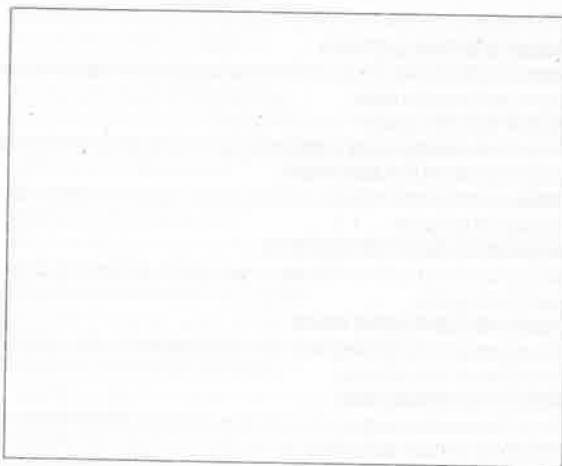

- I **AVVERTENZE:** Prima di utilizzare il compressore, leggere attentamente le istruzioni riportate nel seguente manuale
- GB **WARNING:** Please read understand this manual before operating the compressor
- F **AVERTISSEMENT:** Veuillez lire attentivement toutes les instructions avant de mettre à la sécurité
- D **HINWEIS:** Vor der Benutzung des Kompressors die im vorliegenden Handbuch enthaltenen Anweisungen aufmerksam lesen.
- NL **WAARSCHUWING:** Lees voor het gebruik van de compressor de aanwijzingen in dit handboek zorgvuldig door.
- DK **ADVARSEL:** Før kompressoren tages i brug, skal vejledningerne i følgende manual læses grundigt
- E **ADVERTENCIAS:** Antes de utilizar el compresor, lea atentamente las instrucciones descritas en el presente manual.
- P **AISOS:** antes de utilizar o compressor, ler bem as instruções contidas no seguinte manual
- SF **VAROITUKSET:** Lue tarkkaan tässä käsikirjassa annetut ohjeet ennen kompressorin käyttöä
- S **WARNING:** Läs bruksanvisningens instruktioner noga innan du använder kompressorn

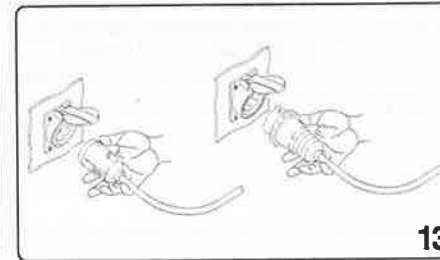
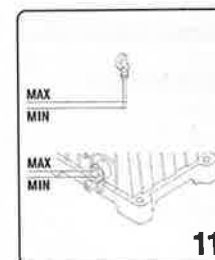
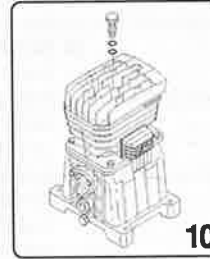
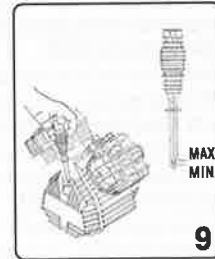
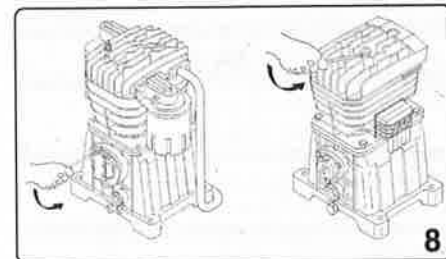
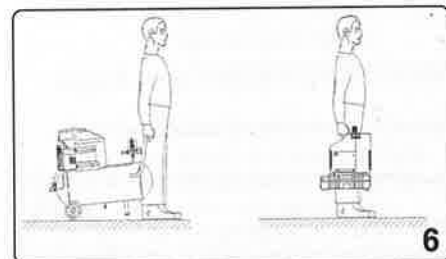
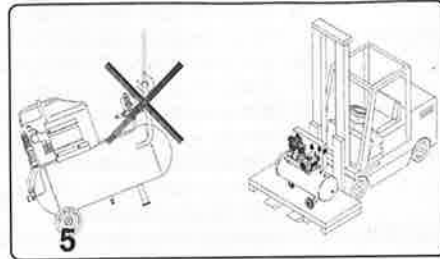
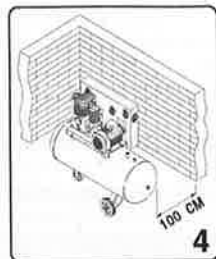
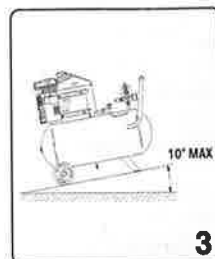
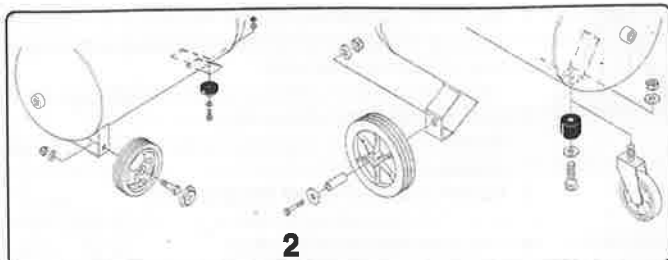

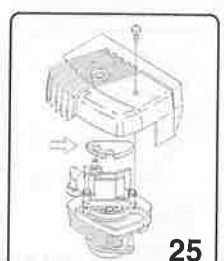
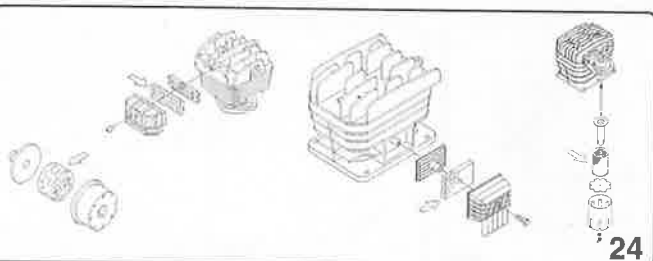
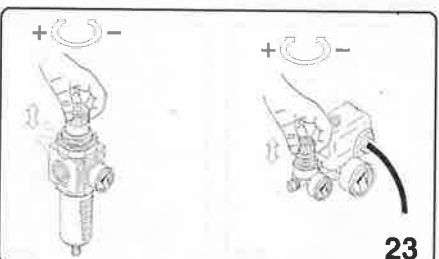
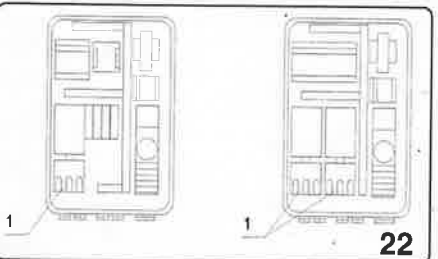
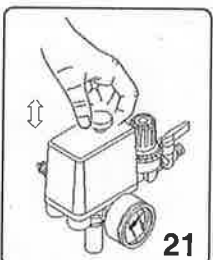
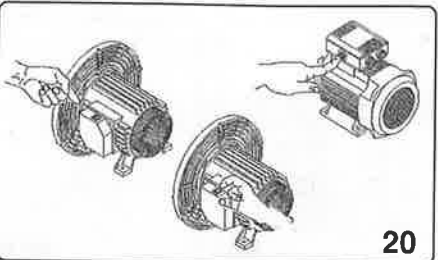
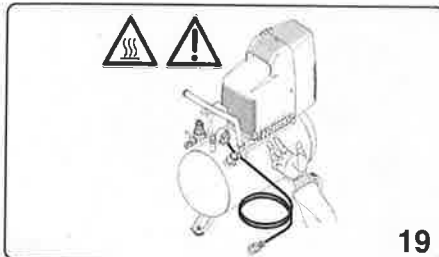
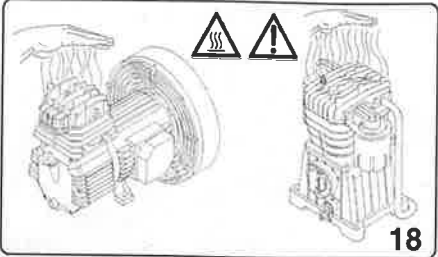
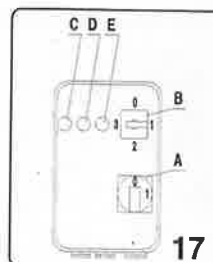
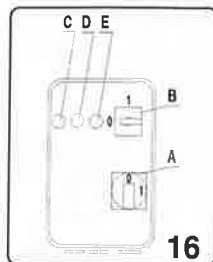
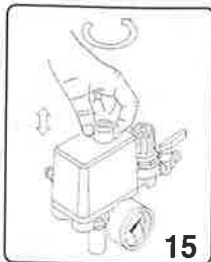
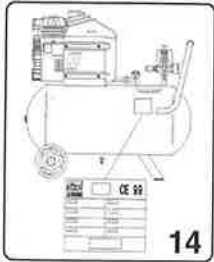

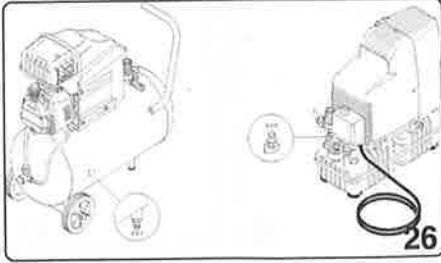

26



27

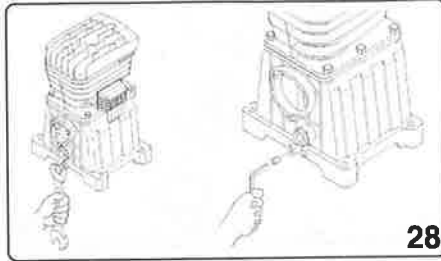

28

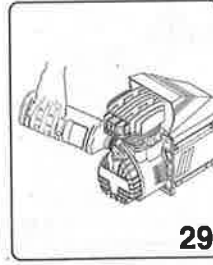

29

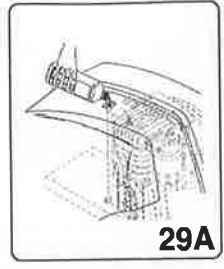

29A

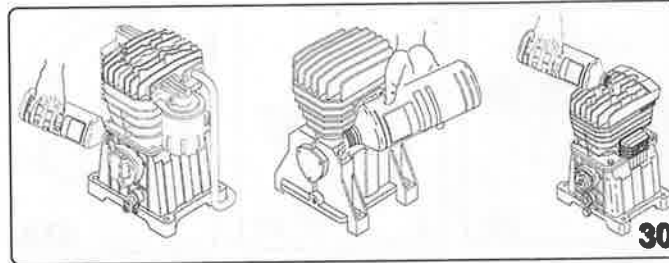

30

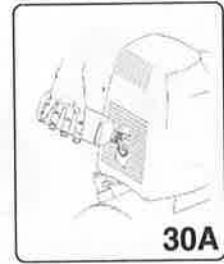

30A

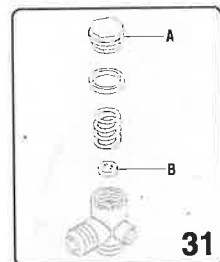

31

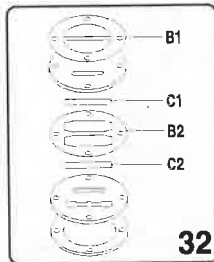

32

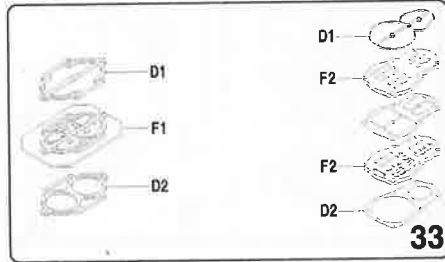

33

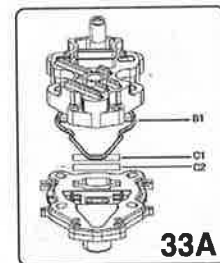

33A

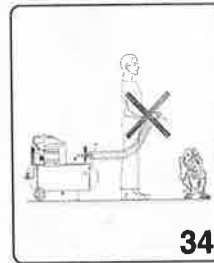

34



35

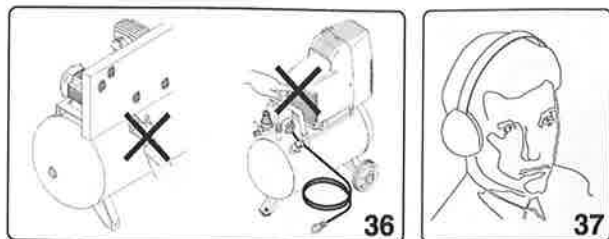

**GM 203**



**SILENT VX**

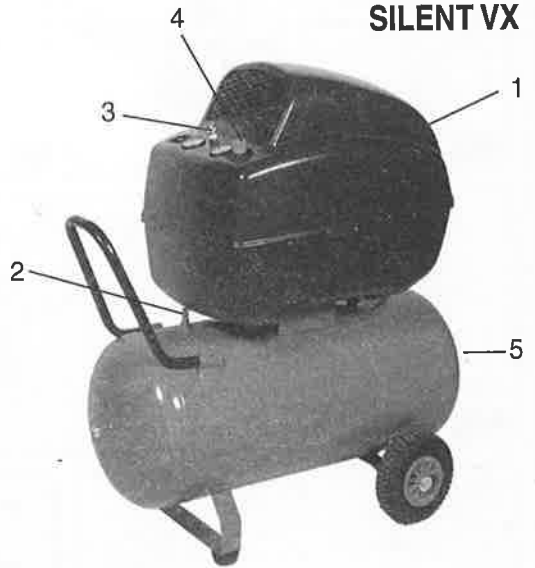

**SILENT AB**

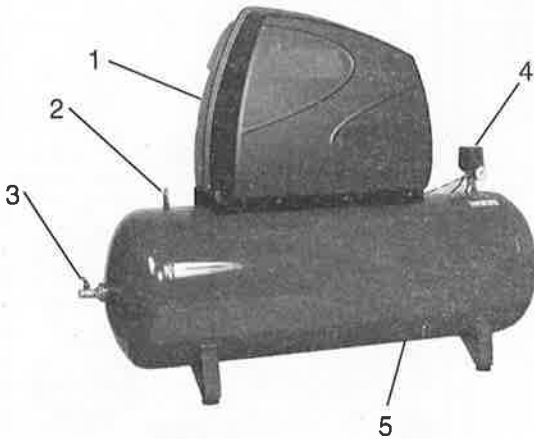

GM

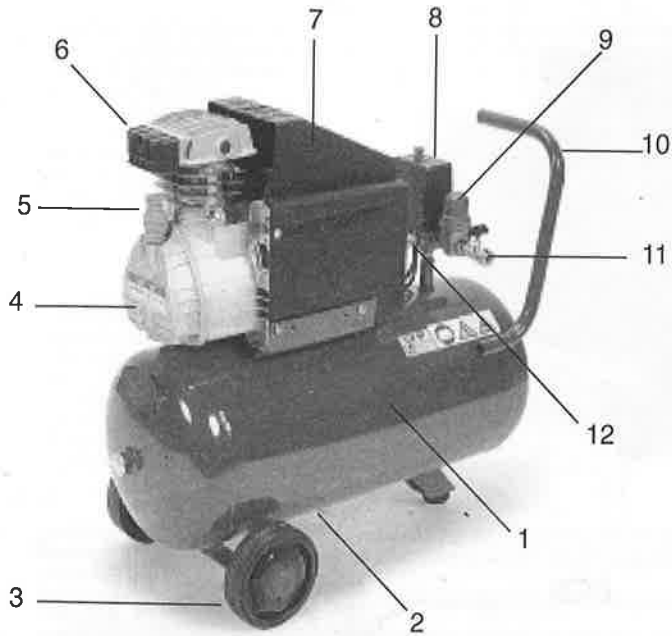

VX

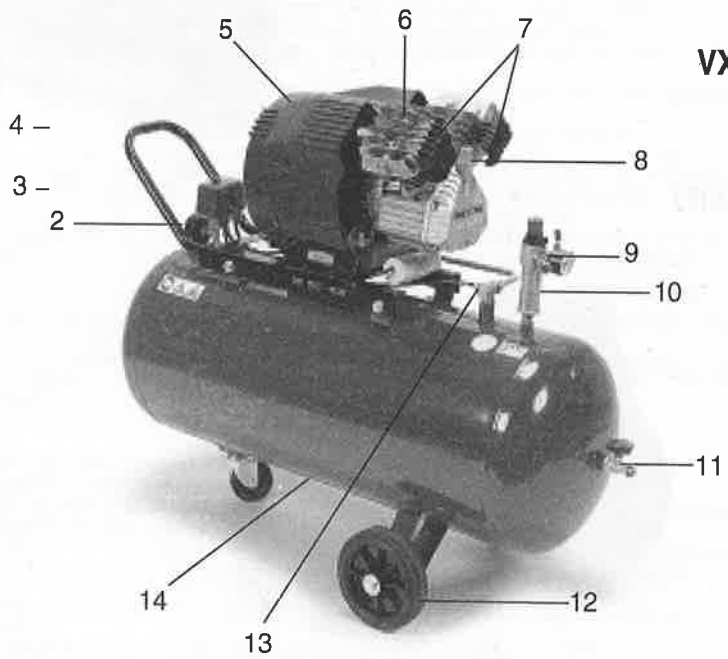

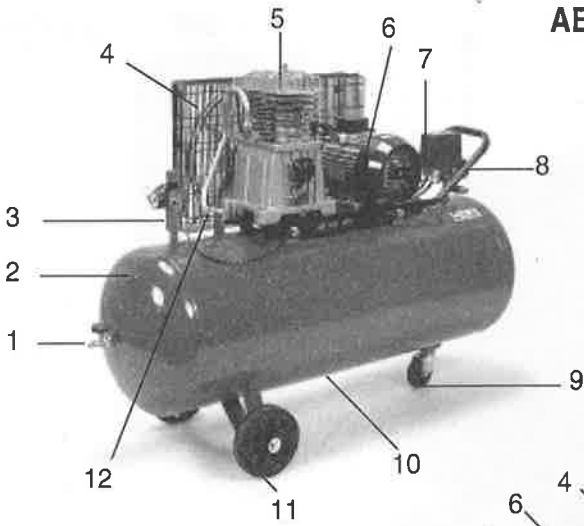
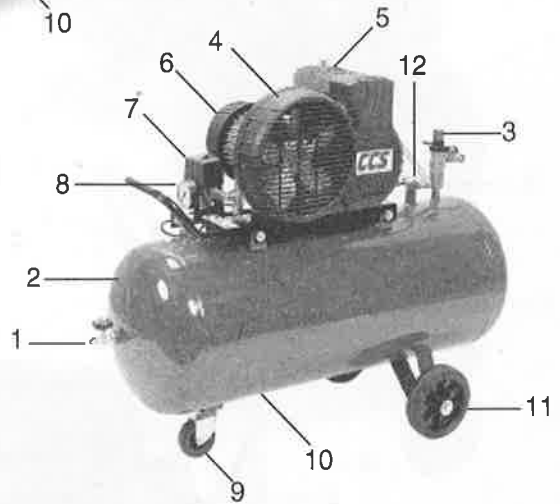
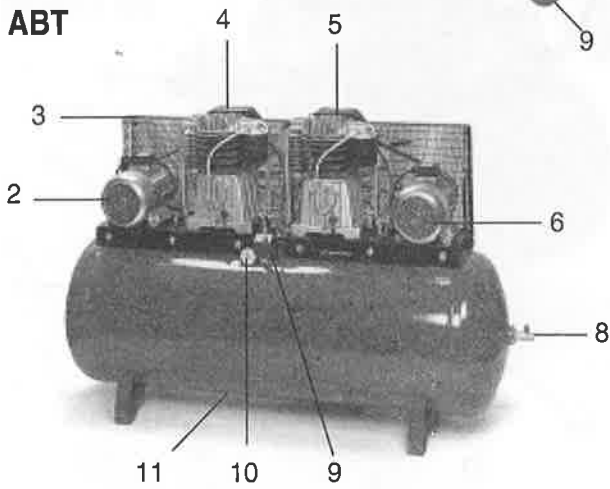
**AB****CCS****ABT**



## IMPORTANT INFORMATION

Read and understand all of the operating instructions, safety precautions and warnings in the Instruction Manual before operating or maintaining this compressor.

Most accidents that result from compressor operation and maintenance are caused by the failure to observe basic safety rules or precautions. An accident can often be avoided by recognizing a potentially hazardous situation before it occurs, and by observing appropriate safety procedures.

Basic safety precautions are outlined in the "SAFETY" section of this Instruction Manual and in the sections which contain the operation and maintenance instructions.

Hazards that must be avoided to prevent bodily injury or machine damage are identified by WARNINGS on the compressor and in this Instruction Manual.

Never use this compressor in a manner that has not been specifically recommended by manufacturer, unless you first confirm that the planned use will be safe for you and others.

### MEANINGS OF SIGNAL WORDS

**WARNING:** indicates a potentially hazardous situations which, if ignored, could result in serious personal injury.

**CAUTION:** indicates a hazardous situations which, if ignored, could result in moderate personal injury, or could cause machine damage.

**NOTE:** emphasizes essential information

## SAFETY

### IMPORTANT SAFETY INSTRUCTIONS FOR USE OF THE COMPRESSOR.

#### WARNING:

DEATH OR SERIOUS BODILY INJURY COULD RESULT FROM IMPROPER OR UNSAFE USE OF COMPRESSOR. TO AVOID THESE RISKS, FOLLOW THESE BASIC SAFETY INSTRUCTIONS.

#### READ ALL INSTRUCTIONS

1. **NEVER TOUCH MOVING PARTS**  
Never place your hands, fingers or other body parts near the compressor's moving parts.
2. **NEVER OPERATE WITHOUT ALL GUARDS IN PLACE**  
Never operate this compressor without all guards or safety features in place and in proper working order. If maintenance or servicing requires the removal of a guard or safety features, be sure to replace the guards or safety feature before resuming operation of the compressor.
3. **ALWAYS WEAR EYE PROTECTION**  
Always wear safety goggles or equivalent eye protection. Compressed air must never be aimed at anyone or any part of the body.
4. **PROTECT YOURSELF AGAINST ELECTRIC SHOCK**  
Prevent body contact with grounded surfaces such as pipes, radiators, ranges and refrigeration enclosures. Never operate the compressor in damp or wet locations.
5. **DISCONNECT THE COMPRESSOR**  
Always disconnect the compressor from the power source and remove the compressed air from the air tank before servicing, inspecting, maintaining, cleaning, replacing or checking any parts.
6. **AVOID UNINTENTIONAL STARTING**  
Do not carry the compressor while it is connected to its power source or when the air tank is filled with compressed air. Be sure the knob of the pressure switch in the "OFF" position before connecting the compressor to its power source.
7. **STORE COMPRESSOR PROPERLY**  
When not in use, the compressor should be stored in dry place. Keep out of reach of children. Lock-out the storage area.
8. **KEEP WORK AREA CLEAN**  
Cluttered areas invite injuries. Clear all work areas of unnecessary tools, debris, furniture etc. . .
9. **KEEP CHILDREN AWAY**  
Do not let visitors contact compressor extension cord. All visitors should be kept safely away from work area.
10. **DRESS PROPERLY**  
Do not wear loose clothing or jewelry. They can be caught in moving parts. Wear protective hair covering to contain long hair.
11. **DON'T ABUSE CORD**  
Never yank it to disconnect from receptacle. Keep cord from heat, oil and sharp edges.
12. **MAINTAIN COMPRESSOR WITH CARE**  
Follow instructions for lubricating. Inspect cords periodically and if damaged, have repaired by authorized service facility. Inspect extension cords periodically and replace if damaged.
13. **OUTDOOR USE EXTENSION CORDS**  
When compressor is used outdoors, use only extension cords intended for use outdoors and so marked.
14. **STAY ALERT**  
Watch what you are doing. Use common sense. Do not operate compressor when you are tired.  
Compressor should never be used by you if you are under the influence of alcohol, drugs or medication that makes you drowsy.
15. **CHECK DAMAGED PARTS AND AIR LEAK**  
Before further use of the compressor, a guard or other part is damaged should be carefully checked to determine that it will operate properly and perform its intended function.  
Check for alignment of moving parts, binding of moving parts, breakage of parts, mounting, air leak, and any other conditions that may affect its operation.  
A guard or other part that is damaged should be properly repaired or replaced by an authorized service center unless otherwise indicated elsewhere in this Instruction Manual. Have defective pressure switches replaced by authorized service center.  
Do not use compressor if switch does not turn it on and off.
16. **HANDLE COMPRESSOR CORRECTLY**  
Operate the compressor according to the instructions provided herein. Never allow the compressor to be operated by children, individuals unfamiliar with its operation or unauthorized personnel.
17. **KEEP ALL SCREWS, BOLTS AND COVERS TIGHTLY IN PLACE**  
Keep all screws, bolts, and plates tightly mounted. Check their conditions periodically.
18. **KEEP MOTOR AIR VENT CLEAN**  
The motor air vent must be kept clean so that air can freely flow at all times. Check for dust build-up frequently.
19. **OPERATE COMPRESSOR AT THE RATED VOLTAGE**  
Operate the compressor at voltages specified on their nameplates. If using the compressor at a higher voltage than the rated voltage, it will result in abnormally fast motor revolution and may damage the unit and burn out the motor.
20. **NEVER USE A COMPRESSOR WHICH IS DEFECTIVE OR OPERATING ABNORMALLY**  
If the compressor appears to be operating unusually, making strange noises, or otherwise appears defective, stop using it immediately and arrange for repairs by a authorized service center.
21. **DO NOT WIPE PLASTIC PARTS WITH SOLVENT**  
Solvents such as gasoline, thinner, benzine, carbon tetrachloride, and alcohol may damage and crack plastic parts. Do not wipe them with such solvents. Wipe plastic parts with a soft cloth lightly

dampened with soapy water and dry thoroughly.

## 22. USE ONLY GENUINE REPLACEMENT PARTS

Replacement parts not original may void your warranty and can lead to malfunction and resulting injuries. Genuine parts are available from your dealer.

## 23. DO NOT MODIFY THE COMPRESSOR

Do not modify the compressor. Always contact the authorized service center any repairs. Unauthorized modification may not only impair the compressor performance but may also result in accident or injury to repair personnel who do not have the required knowledge and technical expertise to perform the repair operations correctly.

## 24. TURN OFF THE PRESSURE SWITCH WHEN THE COMPRESSOR IS NOT USED

When the compressor is not used, turn the knob of the pressure switch OFF, disconnect it from the power source and open the drain cock to discharge the compressed air from the air tank.

## 25. NEVER TOUCH HOT SURFACE

To reduce the risk of burns, do not touch tubes, heads, cylinder and motors.

## 26. DO NOT DIRECT AIR STREAM AT BODY

Risk of injury, do not direct air stream at persons or animals.

## 27. DRAIN TANK

Drain tank daily or after 4 hours of use.

Open drain fitting and tilt compressor to empty accumulated water.

## 28. DO NOT STOP COMPRESSOR BY PULLING OUT THE PLUG

Use the "AUTO/OFF" knob of pressure switch.

## 29. USE ONLY RECOMMENDED AIR HANDLING PARTS ACCEPTABLE FOR PRESSURE NOT LESS THAN 125 PSI (8.6 BAR)

Risk of bursting. Use only recommended air handling parts acceptable for pressures not less than 125 psi (8.6 bar).

### REPLACEMENT PARTS

When servicing use only identical replacement parts.

Repairs should be conducted only by authorized service center.

## SAFETY - continued

### GROUNDING INSTRUCTIONS

This compressor should be grounded while in use to protect the operator from electric shock. The compressor is equipped with a three-conductor cord and three-prong grounding type plug to fit the proper grounding type receptacle.

The green (or green and yellow) conductor in the cord is the grounding wire. Never connect the green (or green and yellow) wire to a live terminal. If your units is for use on less than 150 volts, it has a plug that looks like that shown in sketch (A) in figure on the right. An adapter, see sketches (B) and (C), is available for connecting sketch (A) type plugs to two-prong receptacles. The green-colored rigid ear, lug, or the like extending from the adapter must be connected to a permanent ground, such as a properly grounded outlet box.

**NOTE:** the grounding adaptor, sketch (C), is prohibited in Canada by Canadian Electrical Code Part 1. Therefore, the instructions for its use are not applicable in Canada.

### EXTENSION CORD

Use only three-extension cords that have three-prong grounding type plugs and three-pole receptacles that accept the compressor's plug. Replace or repair damaged cord. Make sure your extension cord is in good condition. When using an extension cord, be sure to use one heavy enough to carry the current your product will draw. An undersized cord will cause a drop in line voltage resulting in loss of power and overheating. Table shows the correct size to use depending on cord length and name

plate ampere rating. If in doubt, use the next heavier gage. The smaller the gage number, the heavier the cord.

Tab. 1 SECTION VALID FOR A MAX LENGHT OF 20 mt single-phase

CV	kW	220/230V mm <sup>2</sup>	110/120V mm <sup>2</sup>
0,75 - 1	0,65 - 0,7	1,5	2,5
1,5	1,1	2,5	4
2	1,5	2,5	4 - 6
2,5 - 3	1,8 - 2,2	4	/

The diameter of the extension cable of the 3-phase compressors must be in proportion to its length: see table (tab 2)

Tab. 2 SECTION VALID FOR A MAX LENGHT OF 20 mt three-phase

CV	kW	220/230V mm <sup>2</sup>	380/400V mm <sup>2</sup>
2 - 3 - 4	1,5 - 2,2 - 3	2,5	1,5
5,5	4	4	2
7,5	5,5	6	2,5
10	7,5	10	4

### WARNING

Avoid electrical shock hazard. Never use this compressor with a damaged or frayed electrical cord or extension cord. Inspect all electrical cords regularly. Never use in near water or in any environment where electric shock is possible

**SAVE THESE INSTRUCTION AND  
MAKE THEM AVAILABLE TO OTHER USERS OF THIS TOOL!**

### OPERATION AND MAINTENANCE

**NOTE:** The information contained in this Instruction Manual is designed to assist you in the safe operation and maintenance of the compressor. Some illustrations in this Instruction Manual may show details or attachments that differ from those on your own compressor.

### INSTALLATION

Remove the compressor from its packing (fig.1), makes sure it is in perfect condition, checking if it was damaged during transport, and carry out the following operations. Fit the wheels and rubber tab on the tanks on which they are not already fitted, observing the instructions in fig.2. In case of inflatable wheels, the maximum inflation pressure must be of 1,6 bar (24 psi). Position the compressor on a flat surface or with a maximum permissible inclination of 10° (fig. 3), in a well aired place, protected against atmospheric agents and not in a place subject to explosion hazard. If the surface is inclined and smooth, check if the compressor moves while in operation - if it does, secure the wheels with two wedges. If the surface is a bracket or a shelf top, make sure it cannot fall, securing it in a suitable way. To ensure good ventilation and efficient cooling, the compressor's belt guard must be at least 100 cm from any wall (fig. 4). Compressors fitted on the tank, with fixed feet, should not be rigidly secured to the ground. In this case, we advise you to fit 4 anti-vibration supports.

### USE INSTRUCTIONS

- Take care to transport the compressor correctly, do not overturn it or lift it with hooks or ropes (fig. 5 - 6)
- Replace the plastic plug on the guard cover (fig. 7 - 8) with the oil level stick (fig. 9) or with the relevant breather plug (fig. 10), supplied with the instructions booklet. Check oil level, consulting the reference marks on the stick (fig. 9) or the oil level inspection window (fig. 11).

### ELECTRICAL CONNECTION

**Single-phase compressors** are supplied with an electrical cable and a two-pole + earth plug. The compressor **must** be connected to a grounded power socket (fig. 12).

**Three-phase compressors** (L1+L2+L3+PE) must be installed by a specialised technician. Three-phase compressors are supplied without a plug. Connect a plug, with screw-on grommet and securing collar (fig. 13), to the cable, consulting the table below.

HP	kW	Power supply volt/Ph Plug model
2 - 3 - 4	1.5 - 2.2 - 3	220/380/3 230/400/3 16A 3 pole + ground
5.5 - 7.5 - 10	4 - 5.5 - 7.5	220/380/3 230/400/3 32A 3 pole + ground

**NOTE:** Compressors installed on the 500 lt tank, with capacity of HP7.5/55 kW and HP10/7.5 kW can be supplied a star/triangle starting control unit, whereas the TANDEM (n. 2 pumping elements on the same tank) are supplied with a timed control unit for staggered starting of the two pumping elements.

Installation instructions:

- Secure the control unit box on a wall or on a fixed support, and provide it with a power cable with plug, of a diameter in proportion to its length.
- Any damage caused by incorrect connections of the power line to the mains, automatically excludes warranty of electrical parts. To avoid connection errors, we advise you to contact a specialised technician.

#### IMPORTANT:

Never use the ground socket instead of the neutral wire. The ground connection must be made to meet safety standards (EN 60204).

The plug of the power cable must not be used as a switch, but must be fitted in a power socket controlled by a suitable differential switch (thermal-breaker).

#### STARTING

Check that the mains power matches that indicated on the electrical data-plate (fig. 14) – the permissible tolerance range is +/-5%. When first starting compressors operating on 3-phase voltage, check the rotation direction of the cooling fan by comparing it with the direction of the arrow on the belt guard or on the protective housing. In the SILENT compressor, check if the air flows in the direction illustrated in fig. 21 A. Turn or press into position "0" (according to the type of pressure switch fitted on the appliance) the knob located on the upper section (fig. 15). Fit the plug in the power socket (fig. 12 - 13) and start the compressor, turning the pressure switch knob into position "I". The compressor is fully automatic, and is controlled by the pressure switch which stops it when tank pressure reaches maximum value and restarts it when it falls to minimum value. The pressure difference between maximum and minimum values is usually about 2 bar (29 psi).

E.g.: the compressor stops when it reaches 8 bar (116 psi – maximum operating pressure) and restarts automatically when the pressure inside the tank drops to 6 bar (87 psi).

After connecting the compressor to the power line, load it to maximum pressure and check exactly how the machine is operating.

#### COMPRESSORS WITH $\Delta$ STARTING CONTROL UNIT (fig. 16)

Fit the plug in the power socket (fig. 13) and turn the pressure switch to position "I" (ON) (fig. 17). Turn the master power switch "A" on the control unit to position I – power On is signalled by white indicator-light "E" going on. Turn switch "B" to position 1 to start the compressor. If the

solenoid-valve indicator-light "D" and the motor (C) indicator-light (C) go on in that order, this means the machine is operating perfectly (fig. 18).

#### TANDEM COMPRESSORS WITH TIMED CONTROL UNIT (fig. 17)

Fit the plug in the power socket (fig. 13) and turn the pressure switch to position "I" (ON). Turn the master power switch "A" on the control unit to position I – power On is signalled by white indicator-light "E" going on. Turn switch "B" to start the compressor.

Pos. 1 pumping element n. 1 only is operating

Pos. 2 pumping element n. 2 only is operating

Pos. 3 both pumping elements are operating simultaneously, at staggered starting times.

The compressor is fully automatic, and is controlled by the pressure switch which stops it when tank pressure reaches maximum value and restarts it when it falls to minimum value.

**NOTE:** The head/cylinder/delivery tube unit can reach high temperatures. Take care when working near these parts, and do not touch them to avoid possible burns (fig. 18 - 19).

#### IMPORTANT

The electro-compressors must be connected to a power socket protected by a suitable differential switch (thermal-breaker). The motor of GM-TR compressors is equipped with an automatic thermal breaker located inside the winding – this stops the compressor when motor temperature reaches excessively high values.

If the breaker is tripped, the compressors restarts automatically after 10 to 15 minutes. The motors of compressor models VX are supplied with a manually resetting automatic amperometric thermal-breaker, located outside the terminal board cover.

When the breaker is tripped, wait for a few minutes and then reset the breaker manually (fig. 20).

The motors of the AB series compressors are supplied with a manually resetting amperometric thermal-breaker, located on the terminal board cover. When the breaker is tripped, wait for a few minutes and then reset the breaker manually (fig. 20).

The safety device is automatic in three-phase and silent compressors. When the thermal-breaker is tripped, the pressure switch is released to "0" (OFF) position.

Wait for a few minutes and return the pressure switch to "I" (ON) position (with the exception of models: AB 100/245-335 Three-phase - AB 150/245-335 Three-phase - AB 200/245-335 Three-phase). For compressors supplied with a control unit, the thermal-breaker is installed inside the control unit. When the thermal-breaker is tripped, observe the following procedure (fig. 22):

- Turn the switches on the control unit cover to position "0", open the cover and press push-button 1 of the thermal-breaker. Close the cover of the control unit and restart the compressor, observing the operations described in the paragraph "Starting compressors with control unit".

The same instructions apply to compressors powered at 60 Hz.

#### ADJUSTING OPERATING PRESSURE (fig. 23)

You do not have to use the maximum operating pressure at all times. On the contrary, the pneumatic tool being used often requires less pressure. On compressors supplied with a pressure reducer, operating pressure must be correctly adjusted.

Release the pressure reducer knob by pulling it up, adjust pressure to the required value by turning the knob clockwise to increase pressure and anti-clockwise to reduce it. When you have obtained optimum pressure, lock the knob by pressing it downward (fig. 23). For pressure reducers equipped without a pressure gauge, the set pressure can be seen on the graduated scale located on the reducer body.

On pressure reducers equipped with a pressure gauge, pressure can be seen on the gauge itself.

**WARNING:** Some pressure regulators do not have "push to lock", therefore simply turn the knob to adjust the pressure.

### MAINTENANCE

Before attempting any maintenance jobs on the compressor, make sure of the following:

- Master power switch in position "0",
- Pressure switch and the control unit switches all off, in position "0".
- No pressure in the air tank.

Every 50 hours of duty: we advise you to dismantle the suction filter and clean the filtering element by blowing compressed air on it (fig. 24).

You are recommended to replace the filter element at least once if the compressor operates in a clean environment, but more frequently if in a dusty environment.

In the "red-head" models (fig. 25) (TR200 – TR255), the suction filter is located internally under the conveying cover (read-head). Unscrew the three cover securing screws, remove the cover from the guard joint, remove the filter from its seat, and begin cleaning, blowing compressed air in opposite to normal flow direction.

In the Silent model, the filtering element can be replaced by taking off the soundproofing cabinet and proceeding in the same way as for the AB models (fig.29A).

The compressor generates condensate water which accumulates in the tank.

The condensate in the tank must be drained at least once a week, by opening the drain tap (fig. 26) under the tank.

Take care if there is compressed air inside the cylinder, and water could flow out with considerable force. Recommended pressure: 1 – 2 bar max.

Condensate of compressors that are oil lubricated must not be drained into the sewer or dispersed in the environment as it contains oil.

### OIL CHANGES – TOPPING UP WITH OIL

The compressor is filled with synthetic oil "FIAC Oil Synthesis".

We recommend a full change of oil in the pumping element within the first 100 hours of duty.

The soundproofing cabinet is to be taken off first in the Silent model (fig.29A).

Unscrew the oil drain plug on the housing cover, allow all the oil to flow out, and re-screw the plug (fig. 27 - 28).

Pour oil into the upper hole of the housing cover (fig. 29 - 30) until it reaches the level indicated on the stick (fig. 9) or indicator (fig. 11)

Pour oil into the upper hole of the head (fig. 30) in belt assisted units designed for topping up in that area.

For the GM203 series, take the cap off and pour in 85 grams of oil directly from the bottle (see fig. 30a).

Once a week: check oil level of the pumping element (fig. 11) and see if it needs topping up.

For operation at normal temperature in the range -5°C to +40°C, use synthetic oil. The advantage of this oil is that it does not lose its characteristics either in winter or summer.

Do not drain used oil into the sewer or dispose of it in the environment.

### OBSERVE THIS TABLE FOR OIL CHANGES

TYPE OF OIL	HOURS OF DUTY
FIAC Oil Synthesis.....	500
Synthetic oil:	
AGIP Sint 2000 Evolution - BP Visco 5000 - ESSO Ultron -	
MOBIL Mobil 1 - NILS Dimension S - NUOVA STILMOIL	
Arrow5W50.....	400
Other types of oil: mineral multigrade	
SAE 15 W40.....	100

### WHAT TO DO IF SMALL MALFUNCTIONS OCCUR

#### Loss of air in valve under pressure switch

This trouble depends on poor tightness of the check valve – take the following action (fig. 31):

- Discharge all pressure from the tank
- Unscrew the hexagon-head of the valve (A)
- Carefully clean both the rubber disk (B) and its seat.
- Refit all parts accurately.

#### Air losses

These can be caused by poor tightness of a union – check all unions, wetting them with soapy water.

#### Compressor turns but does not load

Coaxial compressors: (fig. 32)

- this may be due to failure of the valves (C1 – C2) or of a seal (B1 – B2): replace the damaged part.

Pulley drive compressors: (fig. 33)

- this may be due to failure of the valves F1 and F2 or of a seal (D1 – D2): replace the damaged part.

GM 203 compressors:

This may be due to the breakage of the valves (C1 - C2) or of the gasket (B1). Replace the damaged part (fig. 16A).

- Check if there is too much condensate water inside the tank.

#### Compressor not starting

If the compressor has trouble starting, check the following :

- Does mains power match that of the data-plate? (fig. 14)
- Are power cable extensions of adequate diameter or length?
- Is the work environment too cold? (under 0°C)
- For series VX/AB: was the thermal-breaker tripped? (fig. 20); in the silent series (fig. 21)
- Is there oil in the housing to ensure lubrication? (fig. 11)
- Is power supplied to the electrical line? (sockets well connected, thermal- breaker, fuses in good condition).

#### Compressor not stopping

- If the compressor does not stop when maximum pressure is reached, the tank safety valve comes into operation. To repair the valve, contact your nearest service centre.

### IMPORTANT

- Do not on any account unscrew any connection while the tank is pressurised – always check if the tank is pressure free.
- Do not drill holes, weld or purposely deform the compressed air tank.
- Do not do any jobs on the compressor unless you have disconnected the power plug.
- Temperature in operating ambient: 0°C +35°C.
- Do not aim jets of water or inflammable liquids on the compressor.
- Do not place inflammable objects near the compressor.
- During down-times, turn the pressure switch to position "0" (OFF).
- Never aim the air jet at people or animals (fig. 34)
- Do not transport the compressor while the tank is pressurised.
- Be careful with regard to some parts of the compressor such as the head and delivery tubes, as they can reach high temperatures. Do not touch these parts to avoid burns.(fig. 18 - 19)
- Transport the compressor, lifting or pulling it with the appropriate grips or handles (fig. 4 - 6)
- Keep children and animals well away from the machine operating area.
- If using the compressor for painting:
  - a) Do not work in closed environments or near to naked flames
  - b) Make sure there is adequate exchange of air at the place of work
  - c) Protect your nose and mouth with an appropriate mask. (fig. 35)
- If the electrical cable or plug are damaged, do not use the compressor and contact an authorised service centre to replace the faulty element with an original spare part.

- If the compressor is located on a shelf or on a top above floor height, it must be secured to prevent it falling while in operation.
- Do not put objects or your hands inside the protective grilles to avoid injury to yourself or damaging the compressor. (fig. 36)
- Do not use the compressor as a blunt object toward things or animals, to avoid serious damage.
- When you have finished using the compressor, always remove the plug from the power socket.

#### ELECTRO-COMPRESSOR MODELS GM - TR

Maximum operating pressure 8,5 bar

Minimum operating pressure 8 bar

#### ELECTRO-COMPRESSOR MODELS VX

Maximum operating pressure 10,5 bar

Minimum operating pressure 10 bar

#### ELECTRO-COMPRESSOR MODELS AB

Maximum operating pressure 10,5 bar

Minimum operating pressure 10 bar

N.B. Two-stage compressors can be supplied on request for use up to 14 bar. In this case:

Maximum operating pressure 14,75 bar

Minimum operating pressure 14 bar

**NOTE:** The Silent model consists of the AB model completed with a soundproofing cabinet. The technical data and the instructions of this manual for the AB models also apply to the derived Silent models.

For the European market, the compressor tanks are manufactured to meet Directive CE2009/105

For the European market, the compressors are manufactured to meet Directive CE2006/42.

Acoustic pressure measured free-field at a distance of 1m:  $\pm 3$ dB(A) at maximum operating pressure. (tab. 3)

HP/kW	GM		HP/kW	VX	
	RPM	dB(A)		RPM	dB(A)
0.65/0,5	1450	73	1.5/1.1	1450	75
0.65/0,5	2800	75	2/1.5	1700-1450	75
0.75/0.65	1700-1450	73	2.5/1.8	14050	75.5
1.5/1.1	3400-2850	75	3/2.2	2850	80
2/1.5	2850	79	/	/	/
2.5/1.8	2850	82			

HP/kW	TR	
	RPM	dB(A)
1.5/1.1	1700-2800	7.6
2/1.5	2800	80

Mod.	AB	
	HP/kW	dB(A)
CCS	2 - 1.5	77
AB 245	2 - 1.5	78
AB 335	3 - 2.25	80
AB 410	3 - 2.25	80
AB 510	4 - 3	85
AB 480	4 - 3	81
AB 530	4 - 3	82
AB 550	5.5 - 4.1	83
AB 671	5.5 - 4.1	84
AB 851	7.5 - 5.5	83
AB 1000	10 - 7.5	88

The level of acoustic pressure can increase from 1 to 10 dB(A) according to the place in which the compressor is installed.

The electric compressors on wheels with power greater than or equal to 3 Hp are intended for indoor use.

#### HINTS FOR EFFICIENT OPERATION

-For efficient operation of the machine at full continuing load and at maximum operating pressure, make sure the temperature of the work environment indoors does not exceed +25°C.

-We advise you to use the compressor at 70% maximum duty per hour at full load as this ensures efficient operation of the product long-term.

#### STORING THE PACKED AND UNPACKED COMPRESSOR

For the whole time that the compressor is not used before unpacking it, store it in a dry place at a temperature between +5°C and +45°C and sheltered away from weather. For the whole time that the compressor is **not used after unpacking it, while waiting to start it up** or due to production stoppages, **place sheets over it** to protect it from dust, which **may settle on the components**. The oil is to be replaced and the **operational efficiency of the compressor is to be checked** if it is not used for long periods.

#### PNEUMATIC CONNECTIONS

Make sure you always use pneumatic tubes for compressed air with maximum pressure characteristics that are adequate for the compressor. Do not attempt to repair tubes if faulty.

**WE RESERVE THE RIGHT TO MAKE ANY  
MODIFICATIONS WITHOUT PRIOR NOTICE WHENEVER  
NECESSARY.**

**GARANZIA:** Si concede garanzia di 12 mesi per gli elettrocompressori a partire dalla data di rivendita documentata. La presente garanzia è concessa soltanto al cliente in regola con i pagamenti.

Il compressore è garantito per un normale funzionamento di 8 ore al giorno in ambiente adatto.

L'installazione deve essere eseguita a regola d'arte. In caso di guasti a causa di difetti di costruzione verificatosi nel periodo di garanzia, il fabbricante sostituirà gratuitamente le parti riconosciute difettose.

Le spese di viaggio e di mano d'opera saranno in ogni caso a carico del cliente.

TIMBRO DEL RIVENDITORE

(I)

Sono esclusi dalla garanzia i danni causati da cattiva manutenzione, da incuria od uso in condizioni inadatte. Sono sempre esclusi dalla garanzia i motori e tutte le altre parti elettriche e di normale usura.

DATA DI CONSEGNA

MODELLO

**WARRANTY:** The electro-compressors are warranted for 12 months as from duly documented date of sale.

This warranty is granted only to clients who are up to date with their payments.

The compressor is warranted for normal operational duty of 8 hours per day in a suitable place.

The compressor must be expertly installed. In the event of trouble caused by manufacturing faults occurring during the warranty period, the manufacturer shall replace free of charge parts recognised as faulty.

Travelling and labour costs shall be, in any event, charged to the client.

DEALER'S RUBBER STAMP

(GB)

The following are excluded from the warranty: damage caused by poor maintenance, negligence and use under unsuitable conditions. The guarantee does not cover motors and all other electrical parts as well as parts subject to wear.

DELIVERY DATE

MODEL

**GARANTEE:** Les électrocompresseurs sont garantis 12 mois à partir de la date d'achat documentée. La présente garantie est accordée au client à jour avec les paiements.

Le compresseur est garanti pour une utilisation normale de 8 heures par jour dans un lieu adapté.

L'installation doit être effectuée selon les règles de l'art.

En cas de pannes à cause de défauts de fabrication constatés durant la période de garantie, le fabricant remplacera gratuitement les pièces défectueuses. Dans tous les cas, les frais de voyage et de main-d'oeuvre restent à la charge du client.

CACHET REVENDEUR

(F)

Les dommages provoqués par un entretien incorrect, manque de soin ou conditions inadaptées sont exclus de la garantie.

Les moteurs, les pièces électriques et les pièces sujettes à usure normale sont aussi exclus de la garantie.

DATE DE LIVRAISON

MODÈLE

**GARANTEE:** Für die Elektrokompresoren wird eine Garantie von 12 Monaten vom Datum des dokumentierten Verkaufs an gewährt. Die vorliegende Garantie bezieht sich ausschließlich auf Kunden, die die Zahlungen ordnungsgemäß geleistet haben. Für den Kompressor wird eine Garantie für einen normalen Betrieb von 8 Stunden täglich in einer ordnungsgemäßen Umgebung gewährt. Die Installation muss sachgerecht ausgeführt worden sein.

Bei Defekten im Garantiezeitraum aufgrund von Konstruktionsfehlern ersetzt der Hersteller kostenlos die als defekt anerkannten Bauteile. Die Reise- und Arbeitskosten der Techniker gehen in jedem Fall zu Lasten des Kunden.

STEMPEL DES VERKÄUFERS

(D)

Aus der Garantie ausgeschlossen sind Schäden, die auf ungenügende Wartung, Nachlässigkeit oder Benutzung unter ungeeigneten Bedingungen zurückzuführen sind. Aus der Garantie ausgeschlossen sind die Motoren sowie die sonstigen elektrischen Komponenten und die normalen

LIEFERDATUM

MODELL